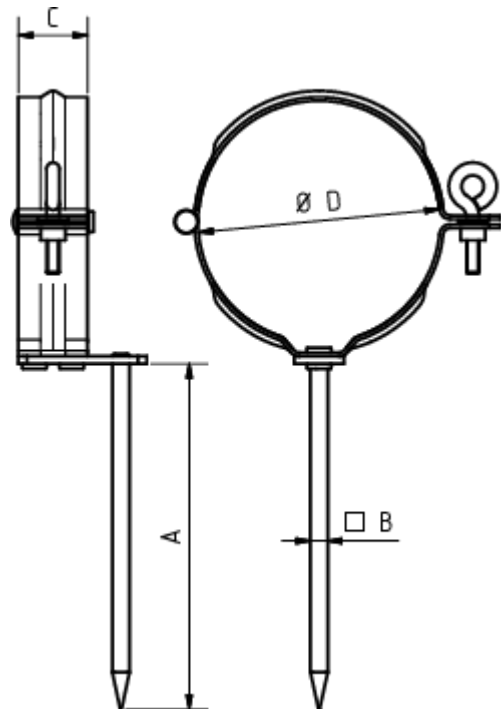

**FALLROHRSCHELLE MIT SCHLAGSTIFT 200
MM**

Art.-Nr.: 50263
Nenngröße [mm]: 60
Material: Stahl verzinkt

**Maße [mm]:**

A	B	C	D
200	7	28	58